

Data Sheet



Article number: 02150000118

Description: Sealing Clamp S 118 W1

Measures

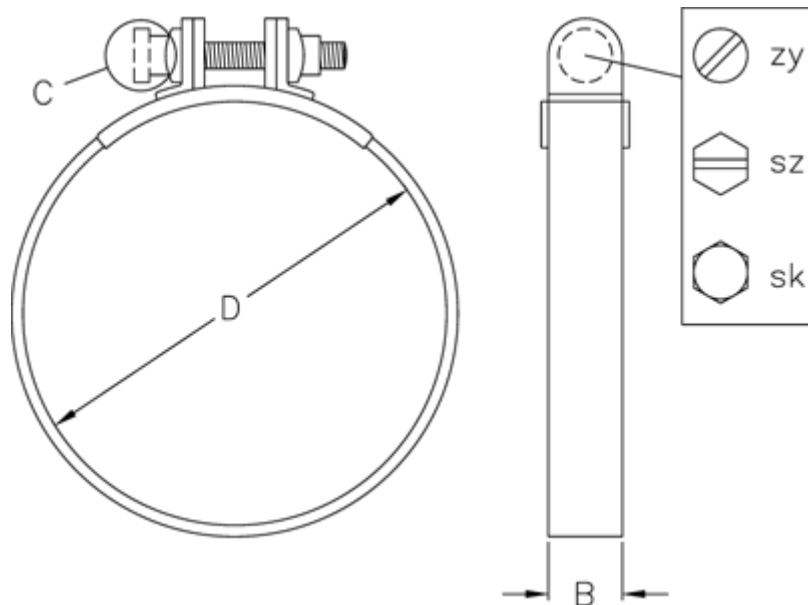

C (screw type)	= SZ
Diameter D	= 118
Width B	= 20